

# Engine Sensor Main Cable

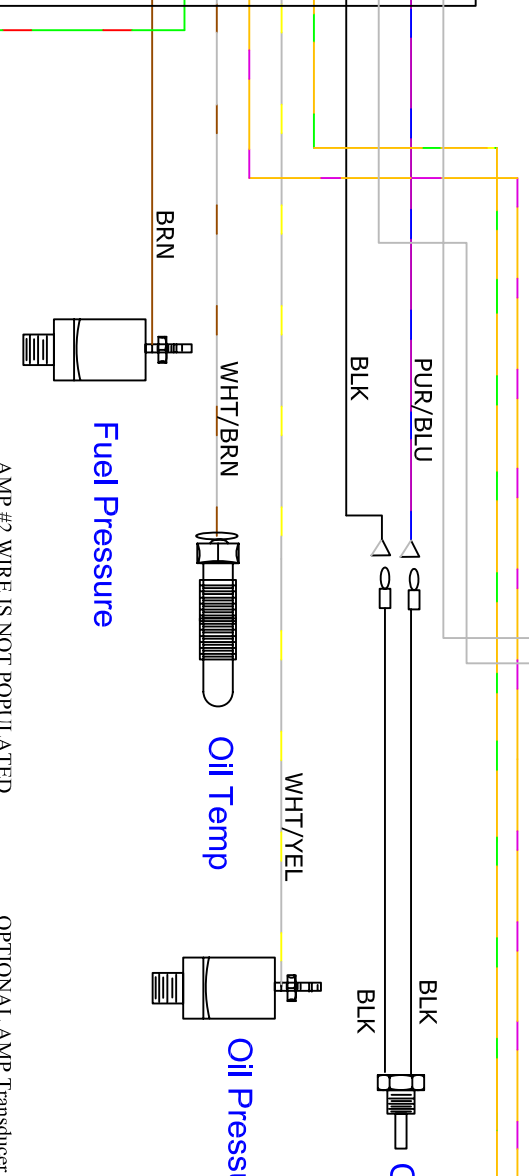

## AF-2500 SENSOR OPTION

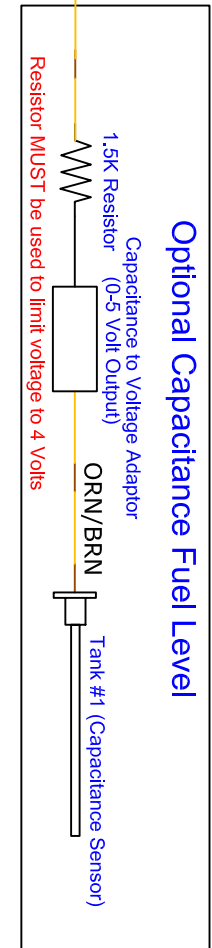
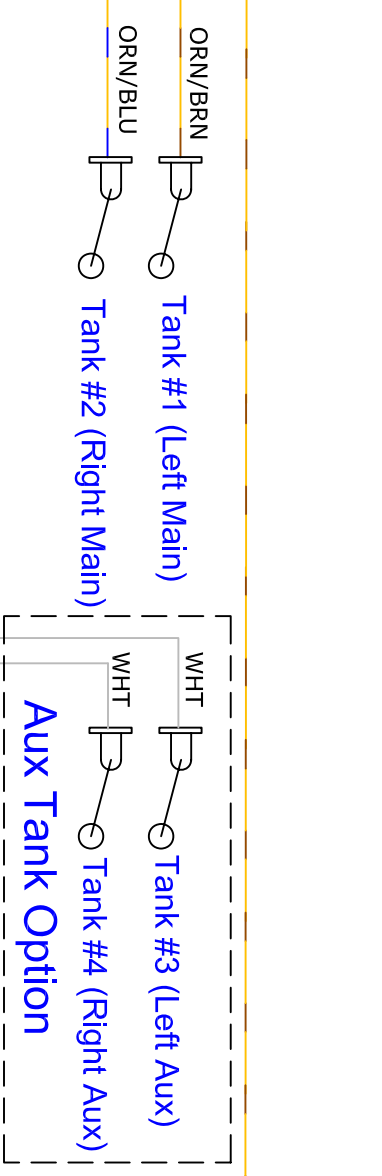
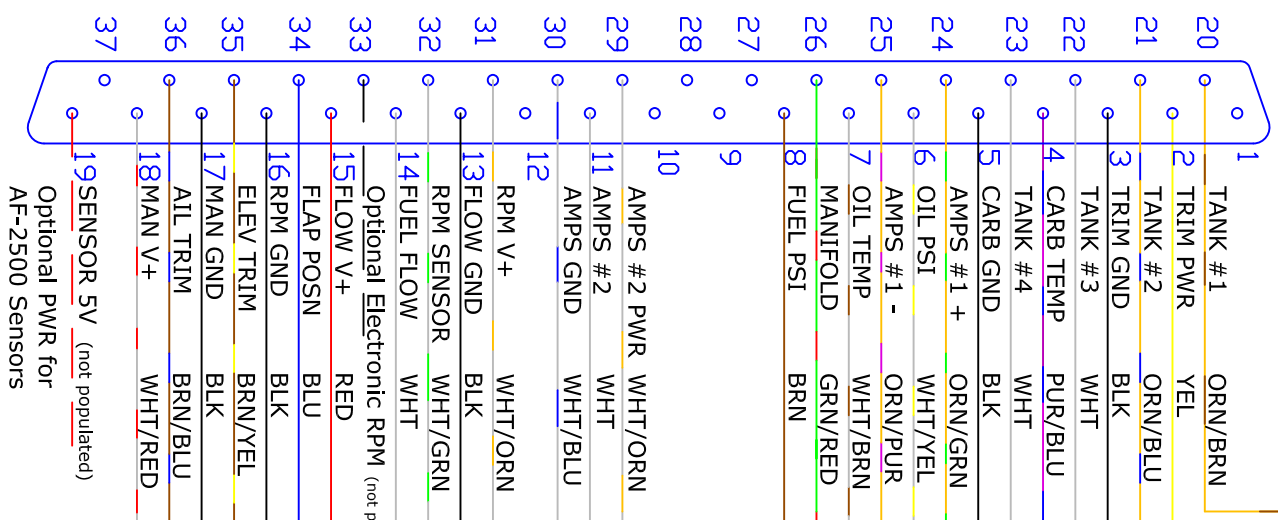
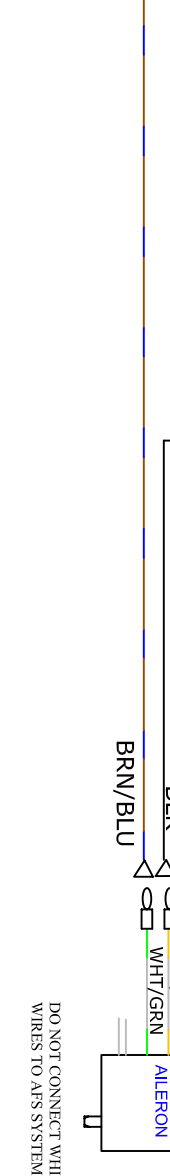
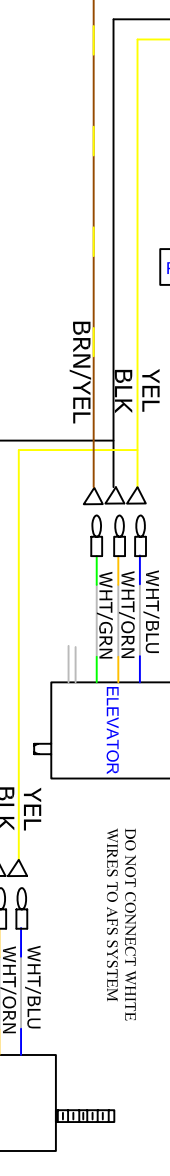
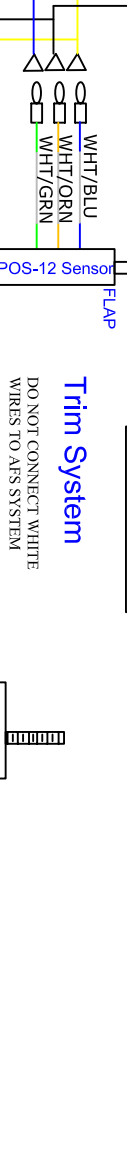
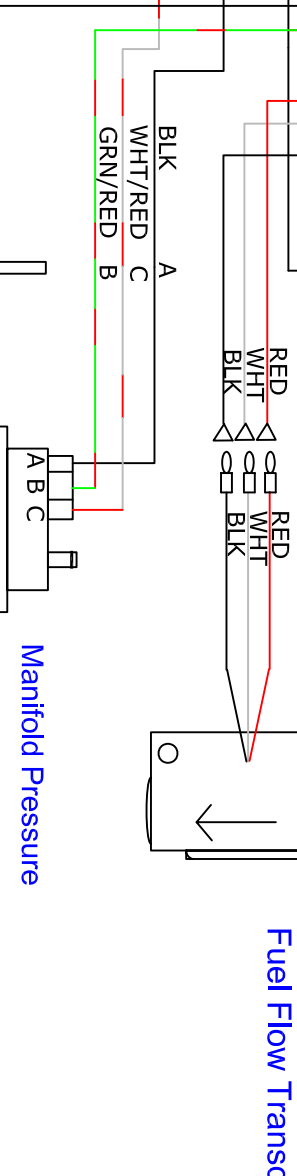
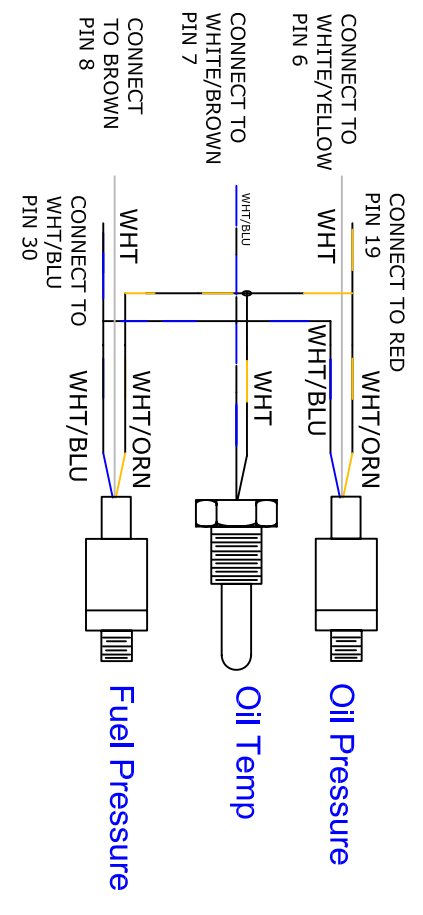

- WHITE
- BLACK
- ORANGE
- BLUE
- YELLOW
- BROWN
- PURPLE
- RED
- GREEN

ENSURE THAT SENSORS ARE PROPERLY GROUNDED TO AIRCRAFT GROUND

REV	DATE	DESCRIPTION	REV BY
3	09/18/08	Moved Amp Transducer to Receiver wire	RAH
2	09/14/08	Changed pin 14 Fuel Flow Sensor from yellow to blue	TOD
1	09/14/08	Initial Drawing	TOD

ITEM	QTY	PART #	DESCRIPTION

DATE	8/14/06	SCALE	NONE
DRN	TOD	APPV	RAH

**ADVANCED FLIGHT SYSTEMS INC.**  
 PHONE: (603) 263-0037 FAX: (603) 263-1138  
 10714 S. TOWNSHIP RD  
 CAMBRI, OR 97103  
 Title: **Writing Diagram** P/N: **53900WD**  
 Engine Sensor Harness REV: **6**